

MINI ONE POST

E9B001- _____ - _____
 base number Color L9
 Temperature Finishes-06-08

- To build a product code in our configurator select the specify button on the base model # product page
- To build a manual product code on this datasheet choose from the options listed below in blue font and add the suffix to the base model #

GENERAL

Series: Mini One
 Brand: Platek
 Division: Exterior
 Mounting Type: Post
 Mounting Location: Above Ground
 Subcategory: Bollard - Mini

PHYSICAL

Shape: Rectangle
 Length (mm): 100
 Length (in): 3 ¹⁵/₁₆
 Width (mm): 100
 Width (in): 3 ¹⁵/₁₆
 Height (mm): 150
 Height (in): 5 ⁷/₈
 Light Distribution: Direct
 Diffuser: Transparent Flat Tempered Glass
 Fixture Finish: GRY / ANT
 Fixture Material: Aluminum Die Cast
 Upon Request: Finishes - Black, White, Bronze, Corten

ELECTRICAL

Lamp Type: LED
 Input Wattage (W): 7.3
 Total Output Wattage (W): 6
 Dimming: Non-Dimmable
 Driver Included: Yes
 Driver Location: Integrated
 Driver Type: Constant Current - 120Vac
 Driver Class: Class 2
 Input Voltage (V): 120 - 277
 Constant Current (mA): 500
 Upon Request: (Not included - see components [IP65 or higher enclosure to be supplied by others]): Remote: 0-10Vdc dimming / Phase dimming / Non-dimming 120/277Vac

LED

Color Temperature (°K): 2700 / 3000 / 4000
 Max. Delivered Lumen (lm): 95 / 100
 Nominal Lumen (lm): 780 / 810
 CRI: >90 CRI
 Lamp Life (hrs): 60000

OPTICAL

Optic°: 1 Opening

RATINGS AND CERTIFICATIONS

Certified By: Certified for North American Standards
 IP rating: IP65
 IK Rating: IK07
 Bug Rating: B0 U0 G0
 Upon Request: Higher Maximum Ambient Temperature

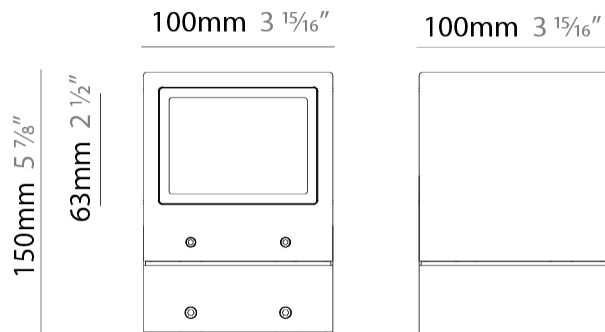

MINI ONE POST

E9B001-

PROJECT

TYPE

SPECIFIER

QUANTITY

DATE



E

MINI ONE POST

E9B002- _____ - _____
 base number Color L9
 Temperature Finishes-06-08

- To build a product code in our configurator select the specify button on the base model # product page
- To build a manual product code on this datasheet choose from the options listed below in blue font and add the suffix to the base model #

GENERAL

Series: Mini One
 Brand: Platek
 Division: Exterior
 Mounting Type: Post
 Mounting Location: Above Ground
 Subcategory: Bollard - Mini

PHYSICAL

Shape: Rectangle
 Length (mm): 100
 Length (in): 3 ¹⁵/₁₆
 Width (mm): 100
 Width (in): 3 ¹⁵/₁₆
 Height (mm): 150
 Height (in): 5 ⁷/₈
 Light Distribution: Direct
 Diffuser: Transparent Flat Tempered Glass
 Fixture Finish: GRY / ANT
 Fixture Material: Aluminum Die Cast
 Upon Request: Finishes - Black, White, Bronze, Corten

ELECTRICAL

Lamp Type: LED
 Input Wattage (W): 7.3
 Total Output Wattage (W): 6
 Dimming: Non-Dimmable
 Driver Included: Yes
 Driver Location: Integrated
 Driver Type: Constant Current - 120Vac
 Driver Class: Class 2
 Input Voltage (V): 120 - 277
 Constant Current (MA): 500
 Upon Request: (Not included - see components [IP65 or higher enclosure to be supplied by others]): Remote: 0-10Vdc dimming / Phase dimming / Non-dimming 120/277Vac

LED

Color Temperature (°K): 2700 / 3000 / 4000
 Max. Delivered Lumen (lm): 195 / 205
 Nominal Lumen (lm): 780 / 810
 CRI: >80 CRI
 Lamp Life (hrs): 60000

OPTICAL

Optic°: 2 Openings

RATINGS AND CERTIFICATIONS

Certified By: Certified for North American Standards
 IP rating: IP65
 IK Rating: IK07
 Bug Rating: B0 U0 G0
 Upon Request: Higher Maximum Ambient Temperature

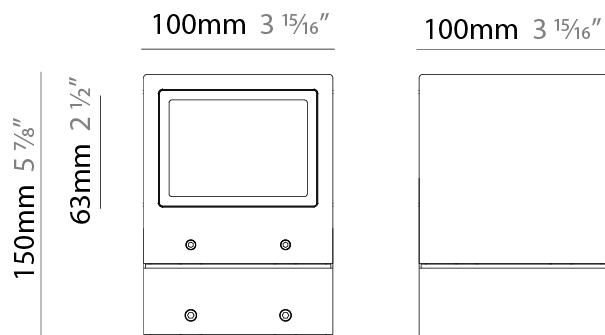

MINI ONE POST

E9B002-

PROJECT

TYPE

SPECIFIER

QUANTITY

DATE



MINI ONE POST

E9B004- _____ - _____
 base number Color L9
 Temperature Finishes-06-08

- To build a product code in our configurator select the specify button on the base model # product page
- To build a manual product code on this datasheet choose from the options listed below in blue font and add the suffix to the base model #

GENERAL

Series: Mini One
 Brand: Platek
 Division: Exterior
 Mounting Type: Post
 Mounting Location: Above Ground
 Subcategory: Bollard - Mini

PHYSICAL

Shape: Rectangle
 Length (mm): 100
 Length (in): 3 ¹⁵/₁₆
 Width (mm): 100
 Width (in): 3 ¹⁵/₁₆
 Height (mm): 150
 Height (in): 5 ⁷/₈
 Light Distribution: Direct
 Diffuser: Transparent Flat Tempered Glass
 Fixture Finish: GRY / ANT
 Fixture Material: Aluminum Die Cast
 Upon Request: Finishes - Black, White, Bronze, Corten

ELECTRICAL

Lamp Type: LED
 Input Wattage (W): 7.3
 Total Output Wattage (W): 6
 Dimming: Non-Dimmable
 Driver Included: Yes
 Driver Location: Integrated
 Driver Type: Constant Current - 120Vac
 Driver Class: Class 2
 Input Voltage (V): 120 - 277
 Constant Current (MA): 500
 Upon Request: (Not included - see components [IP65 or higher enclosure to be supplied by others]): Remote: 0-10Vdc dimming / Phase dimming / Non-dimming 120/277Vac

LED

Color Temperature (°K): 2700 / 3000 / 4000
 Max. Delivered Lumen (lm): 415 / 430
 Nominal Lumen (lm): 780 / 810
 CRI: >90 CRI
 Lamp Life (hrs): 60000

OPTICAL

Optic°: 4 Openings

RATINGS AND CERTIFICATIONS

Certified By: Certified for North American Standards
 IP rating: IP65
 IK Rating: IK07
 Bug Rating: B0 U0 G0
 Upon Request: Higher Maximum Ambient Temperature



MINI ONE POST

E9B004-

PROJECT

TYPE

SPECIFIER

QUANTITY

DATE



PROJECT
TYPE
SPECIFIER
QUANTITY
DATE

MINI ONE POST

E9B008- -
 base number Color L9
 Temperature Finishes-06-08

- To build a product code in our configurator select the specify button on the base model # product page
- To build a manual product code on this datasheet choose from the options listed below in blue font and add the suffix to the base model #

GENERAL

Series: Mini One
 Brand: Platek
 Division: Exterior
 Mounting Type: Post
 Mounting Location: Above Ground
 Subcategory: Bollard

PHYSICAL

Shape: Rectangle
 Length (mm): 100
 Length (in): 3 ¹⁵/₁₆
 Width (mm): 100
 Width (in): 3 ¹⁵/₁₆
 Height (mm): 500
 Height (in): 19 ¹¹/₁₆
 Light Distribution: Direct
 Diffuser: Transparent Flat Tempered Glass
 Fixture Finish: GRY / ANT
 Fixture Material: Aluminum Die Cast
 Upon Request: Finishes - Black, White, Bronze, Corten

ELECTRICAL

Lamp Type: LED
 Input Wattage (W): 9.5
 Total Output Wattage (W): 9
 Dimming: Non-Dimmable
 Driver Included: Yes
 Driver Location: Integrated
 Driver Type: Constant Current - 120Vac
 Driver Class: Class 2
 Input Voltage (V): 120 - 277
 Constant Current (mA): 700
 Upon Request: (Not included - see components [IP65 or higher enclosure to be supplied by others]): Remote: 0-10Vdc dimming / Phase dimming / Non-dimming 120/277Vac

LED

Color Temperature (°K): 2700 / 3000 / 4000
 Max. Delivered Lumen (lm): 110 / 115
 Nominal Lumen (lm): 1040 / 1080
 CRI: >80 CRI
 Lamp Life (hrs): 60000

OPTICAL

Optic°: 1 Opening

RATINGS AND CERTIFICATIONS

Certified By: Certified for North American Standards
 IP rating: IP65
 IK Rating: IK07
 Bug Rating: B0 U0 G0
 Upon Request: Higher Maximum Ambient Temperature

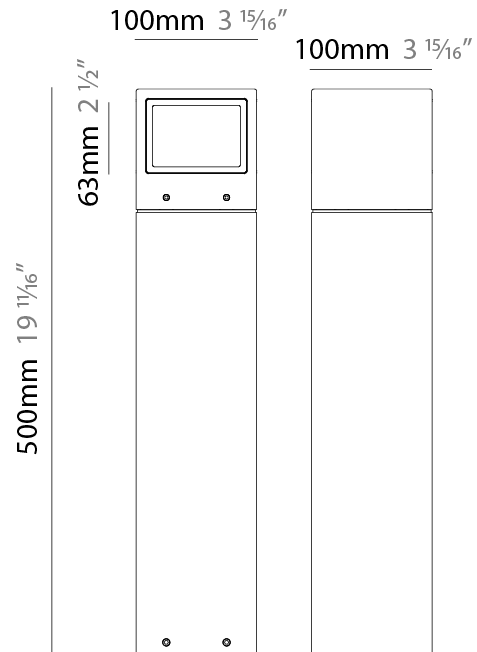

MINI ONE POST

E9B008-

PROJECT

TYPE

SPECIFIER

QUANTITY

DATE

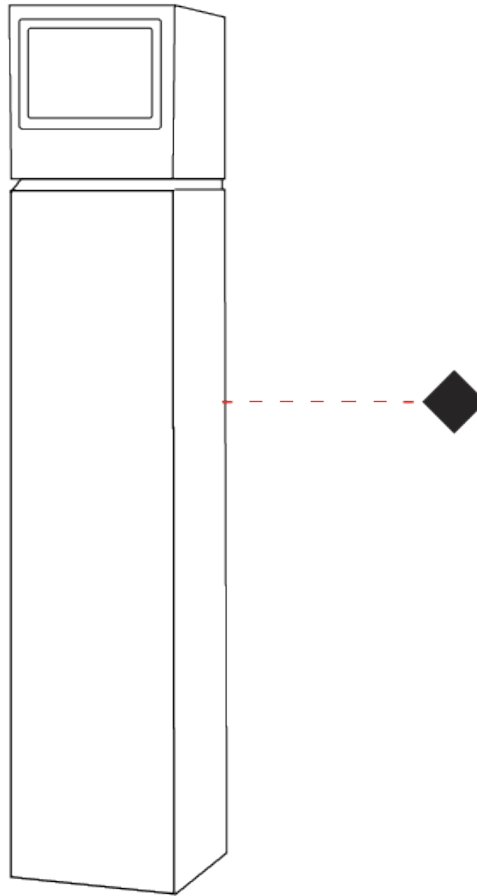

E

PROJECT
TYPE
SPECIFIER
QUANTITY
DATE

MINI ONE POST

E9B009- -
 base number Color L9
 Temperature Finishes-06-08

- To build a product code in our configurator select the specify button on the base model # product page
- To build a manual product code on this datasheet choose from the options listed below in blue font and add the suffix to the base model #

GENERAL

Series: Mini One
 Brand: Platek
 Division: Exterior
 Mounting Type: Post
 Mounting Location: Above Ground
 Subcategory: Bollard

PHYSICAL

Shape: Rectangle
 Length (mm): 100
 Length (in): 3 ¹⁵/₁₆
 Width (mm): 100
 Width (in): 3 ¹⁵/₁₆
 Height (mm): 500
 Height (in): 19 ¹¹/₁₆
 Light Distribution: Direct
 Diffuser: Transparent Flat Tempered Glass
 Fixture Finish: GRY / ANT
 Fixture Material: Aluminum Die Cast
 Upon Request: Finishes - Black, White, Bronze, Corten

ELECTRICAL

Lamp Type: LED
 Input Wattage (W): 9.5
 Total Output Wattage (W): 8
 Dimming: Non-Dimmable
 Driver Included: Yes
 Driver Location: Integrated
 Driver Type: Constant Current - 120Vac
 Driver Class: Class 2
 Input Voltage (V): 120 - 277
 Constant Current (mA): 700
 Upon Request: (Not included - see components [IP65 or higher enclosure to be supplied by others]): Remote: 0-10Vdc dimming / Phase dimming / Non-dimming 120/277Vac

LED

Color Temperature (°K): 2700 / 3000 / 4000
 Max. Delivered Lumen (lm): 230 / 240
 Nominal Lumen (lm): 1040 / 1080
 CRI: >80 CRI
 Lamp Life (hrs): 60000

OPTICAL

Optic°: 2 Openings

RATINGS AND CERTIFICATIONS

Certified By: Certified for North American Standards
 IP rating: IP65
 IK Rating: IK07
 Bug Rating: B0 U0 G0
 Upon Request: Higher Maximum Ambient Temperature

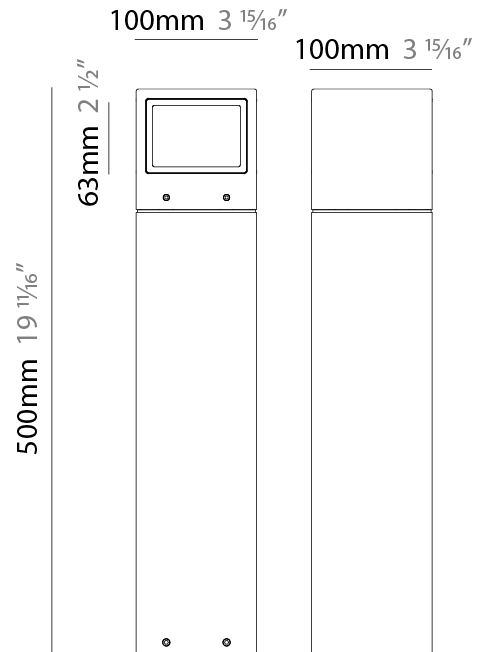

MINI ONE POST

E9B009-

PROJECT

TYPE

SPECIFIER

QUANTITY

DATE

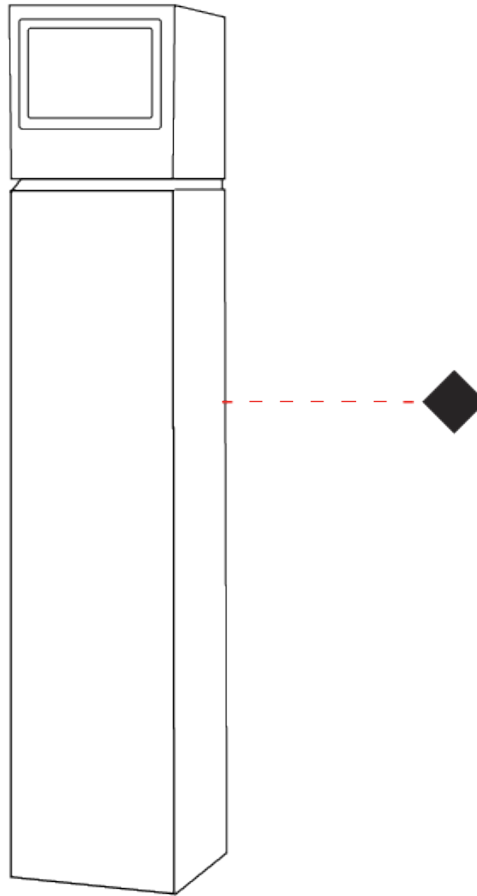

E

PROJECT
TYPE
SPECIFIER
QUANTITY
DATE

MINI ONE POST

E9B010- -
 base number Color L9
 Temperature Finishes-06-08

- To build a product code in our configurator select the specify button on the base model # product page
- To build a manual product code on this datasheet choose from the options listed below in blue font and add the suffix to the base model #

GENERAL

Series: Mini One
 Brand: Platek
 Division: Exterior
 Mounting Type: Post
 Mounting Location: Above Ground
 Subcategory: Bollard

PHYSICAL

Shape: Rectangle
 Length (mm): 100
 Length (in): 3 ¹⁵/₁₆
 Width (mm): 100
 Width (in): 3 ¹⁵/₁₆
 Height (mm): 500
 Height (in): 19 ¹¹/₁₆
 Light Distribution: Direct
 Diffuser: Transparent Flat Tempered Glass
 Fixture Finish: GRY / ANT
 Fixture Material: Aluminum Die Cast
 Upon Request: Finishes - Black, White, Bronze, Corten

ELECTRICAL

Lamp Type: LED
 Input Wattage (W): 9.5
 Total Output Wattage (W): 8
 Dimming: Non-Dimmable
 Driver Included: Yes
 Driver Location: Integrated
 Driver Type: Constant Current - 120Vac
 Driver Class: Class 2
 Input Voltage (V): 120 - 277
 Constant Current (mA): 700
 Upon Request: (Not included - see components [IP65 or higher enclosure to be supplied by others]): Remote: 0-10Vdc dimming / Phase dimming / Non-dimming 120/277Vac

LED

Color Temperature (°K): 2700 / 3000 / 4000
 Max. Delivered Lumen (lm): 490 / 510
 Nominal Lumen (lm): 1040 / 1080
 CRI: >80 CRI
 Lamp Life (hrs): 60000

OPTICAL

Optic°: 4 Openings

RATINGS AND CERTIFICATIONS

Certified By: Certified for North American Standards
 IP rating: IP65
 IK Rating: IK07
 Bug Rating: B0 U0 G0
 Upon Request: Higher Maximum Ambient Temperature



MINI ONE POST

E9B010-

PROJECT _____

TYPE _____

SPECIFIER _____

QUANTITY _____

DATE _____

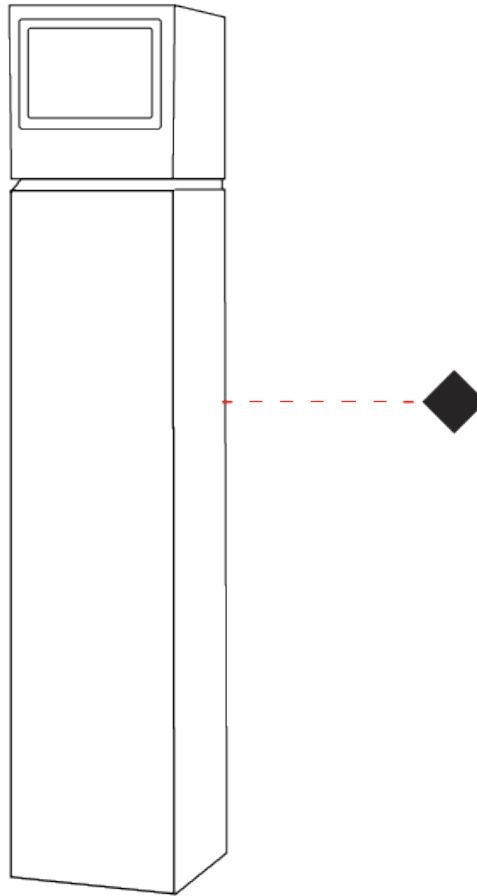

E

PROJECT
TYPE
SPECIFIER
QUANTITY
DATE

MINI ONE POST

E9B246- -
 base number Color L9
 Temperature Finishes-06-08

- To build a product code in our configurator select the specify button on the base model # product page
- To build a manual product code on this datasheet choose from the options listed below in blue font and add the suffix to the base model #

GENERAL

Series: Mini One
 Brand: Platek
 Division: Exterior
 Mounting Type: Post
 Mounting Location: Above Ground
 Subcategory: Bollard

PHYSICAL

Shape: Rectangle
 Length (mm): 100
 Length (in): 3 15/16
 Width (mm): 100
 Width (in): 3 15/16
 Height (mm): 800
 Height (in): 31 1/2
 Light Distribution: Direct
 Diffuser: Transparent Flat Tempered Glass
 Fixture Finish: GRY / ANT
 Fixture Material: Aluminum Die Cast
 Upon Request: Finishes - Black, White, Bronze, Corten

ELECTRICAL

Lamp Type: LED
 Input Wattage (W): 10.5
 Total Output Wattage (W): 9
 Dimming: Non-Dimmable
 Driver Included: Yes
 Driver Location: Integrated
 Driver Type: Constant Current - 120Vac
 Driver Class: Class 2
 Input Voltage (V): 120
 Constant Current (MA): 700

LED

Color Temperature (°K): 2700 / 3000 / 4000
 Max. Delivered Lumen (lm): 110 / 115
 Nominal Lumen (lm): 1040 / 1080
 CRI: >80 CRI
 Lamp Life (hrs): 60000

OPTICAL

Optic°: 1 Opening

RATINGS AND CERTIFICATIONS

Certified By: Certified for North American Standards
 IP rating: IP65
 IK Rating: IK07
 Bug Rating: B0 U0 G0
 Upon Request: Higher Maximum Ambient Temperature

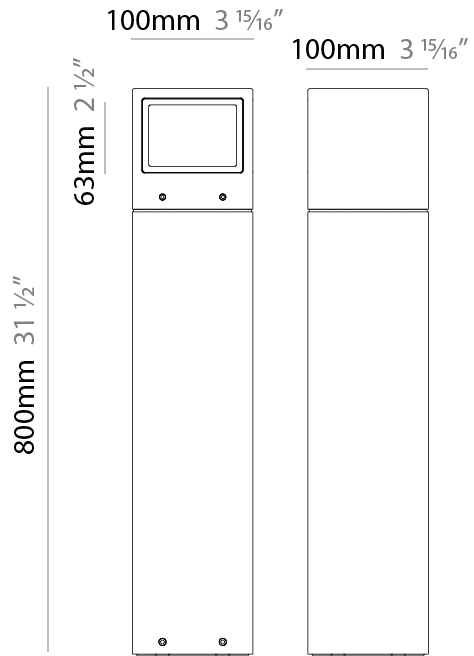

MINI ONE POST

E9B246-

PROJECT

TYPE

SPECIFIER

QUANTITY

DATE

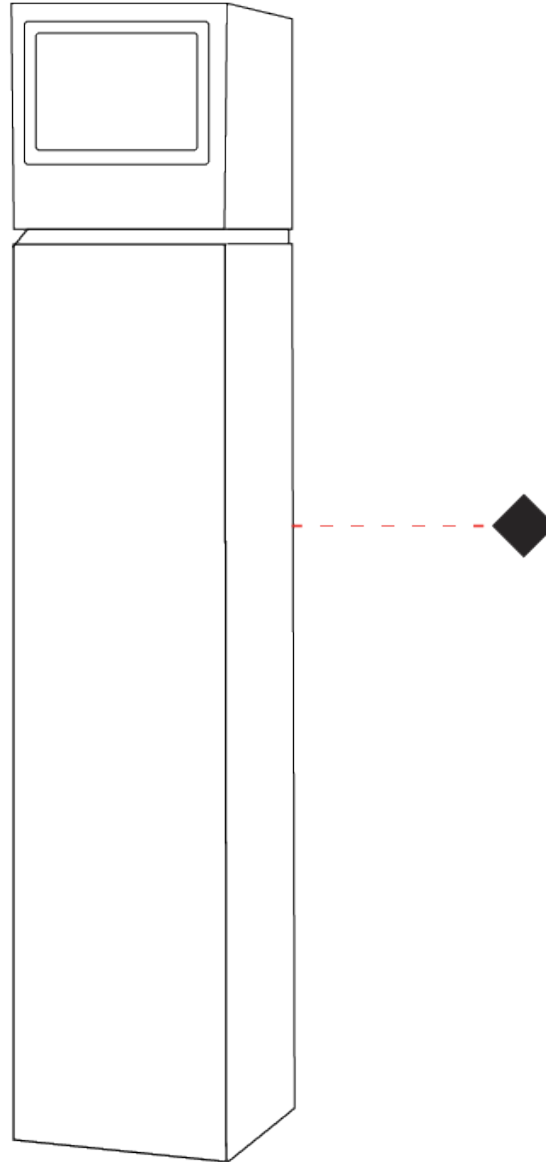

E

PROJECT
TYPE
SPECIFIER
QUANTITY
DATE

MINI ONE POST

E9B247- -
 base number Color L9
 Temperature Finishes-06-08

- To build a product code in our configurator select the specify button on the base model # product page
- To build a manual product code on this datasheet choose from the options listed below in blue font and add the suffix to the base model #

GENERAL

Series: Mini One
 Brand: Platek
 Division: Exterior
 Mounting Type: Post
 Mounting Location: Above Ground
 Subcategory: Bollard

PHYSICAL

Shape: Rectangle
 Length (mm): 100
 Length (in): 3 15/16
 Width (mm): 100
 Width (in): 3 15/16
 Height (mm): 800
 Height (in): 31 1/2
 Light Distribution: Direct
 Diffuser: Transparent Flat Tempered Glass
 Fixture Finish: GRY / ANT
 Fixture Material: Aluminum Die Cast
 Upon Request: Finishes - Black, White, Bronze, Corten

ELECTRICAL

Lamp Type: LED
 Input Wattage (W): 10.5
 Total Output Wattage (W): 9
 Dimming: Non-Dimmable
 Driver Included: Yes
 Driver Location: Integrated
 Driver Type: Constant Current - 120Vac
 Driver Class: Class 2
 Input Voltage (V): 120
 Constant Current (MA): 700

LED

Color Temperature (°K): 2700 / 3000 / 4000
 Max. Delivered Lumen (lm): 230 / 240
 Nominal Lumen (lm): 1040 / 1080
 CRI: >80 CRI
 Lamp Life (hrs): 60000

OPTICAL

Optic°: 2 Openings

RATINGS AND CERTIFICATIONS

Certified By: Certified for North American Standards
 IP rating: IP65
 IK Rating: IK07
 Bug Rating: B0 U0 G0
 Upon Request: Higher Maximum Ambient Temperature

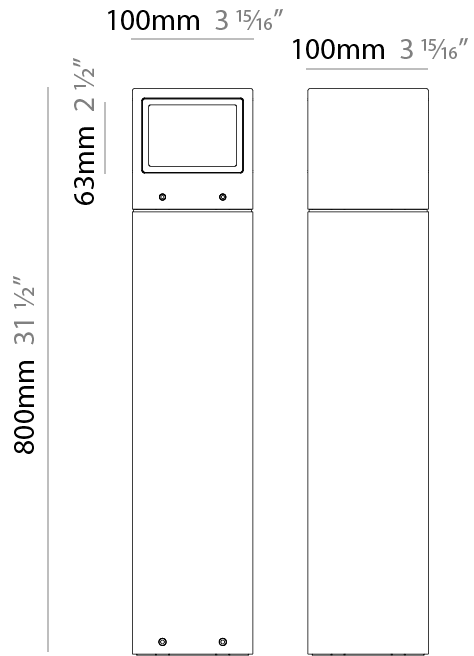

MINI ONE POST

E9B247-

PROJECT

TYPE

SPECIFIER

QUANTITY

DATE

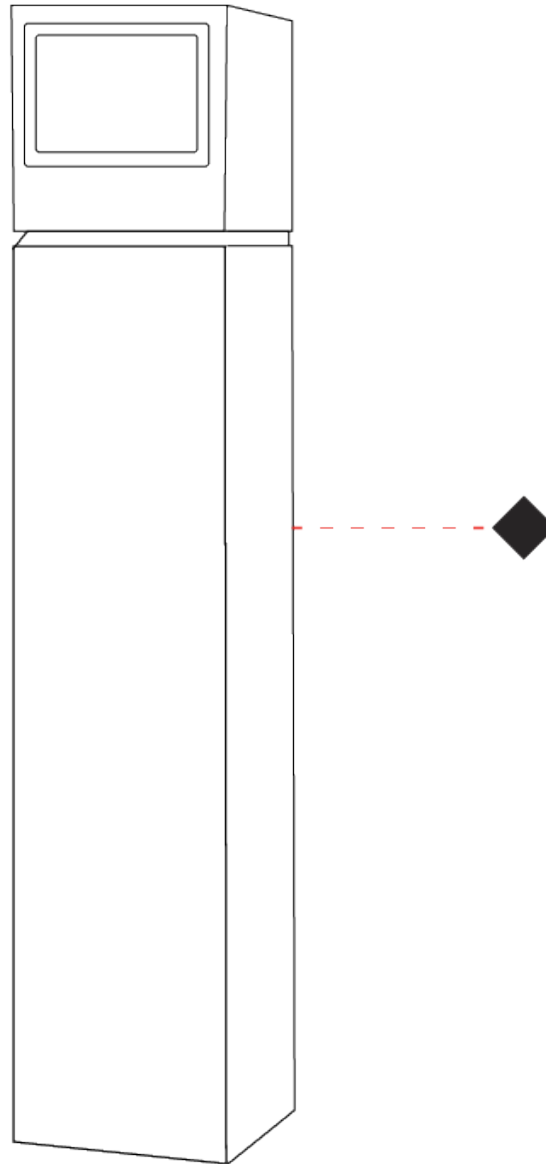

E

PROJECT
TYPE
SPECIFIER
QUANTITY
DATE

MINI ONE POST

E9B248-

base number Color L9
 Temperature Finishes-06-08

- To build a product code in our configurator select the specify button on the base model # product page
- To build a manual product code on this datasheet choose from the options listed below in blue font and add the suffix to the base model #

GENERAL

Series: Mini One
 Brand: Platek
 Division: Exterior
 Mounting Type: Post
 Mounting Location: Above Ground
 Subcategory: Bollard

PHYSICAL

Shape: Rectangle
 Length (mm): 100
 Length (in): 3 15/16
 Width (mm): 100
 Width (in): 3 15/16
 Height (mm): 800
 Height (in): 31 1/2
 Light Distribution: Direct
 Diffuser: Transparent Flat Tempered Glass
 Fixture Finish: GRY / ANT
 Fixture Material: Aluminum Die Cast
 Upon Request: Finishes - Black, White, Bronze, Corten

ELECTRICAL

Lamp Type: LED
 Input Wattage (W): 10.5
 Total Output Wattage (W): 9
 Dimming: Non-Dimmable
 Driver Included: Yes
 Driver Location: Integrated
 Driver Type: Constant Current - 120Vac
 Driver Class: Class 2
 Input Voltage (V): 120
 Constant Current (MA): 700

LED

Color Temperature (°K): 2700 / 3000 / 4000
 Max. Delivered Lumen (lm): 490 / 510
 Nominal Lumen (lm): 1040 / 1080
 CRI: >80 CRI
 Lamp Life (hrs): 60000

OPTICAL

Optic°: 4 Openings

RATINGS AND CERTIFICATIONS

Certified By: Certified for North American Standards
 IP rating: IP65
 IK Rating: IK07
 Bug Rating: B0 U0 G0
 Upon Request: Higher Maximum Ambient Temperature

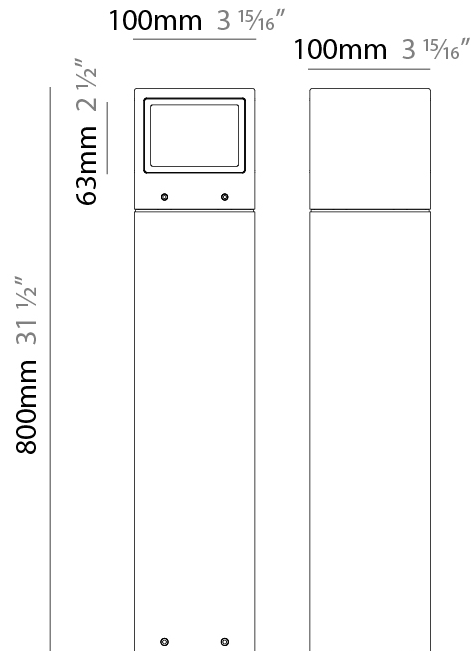

MINI ONE POST

E9B248-

PROJECT

TYPE

SPECIFIER

QUANTITY

DATE

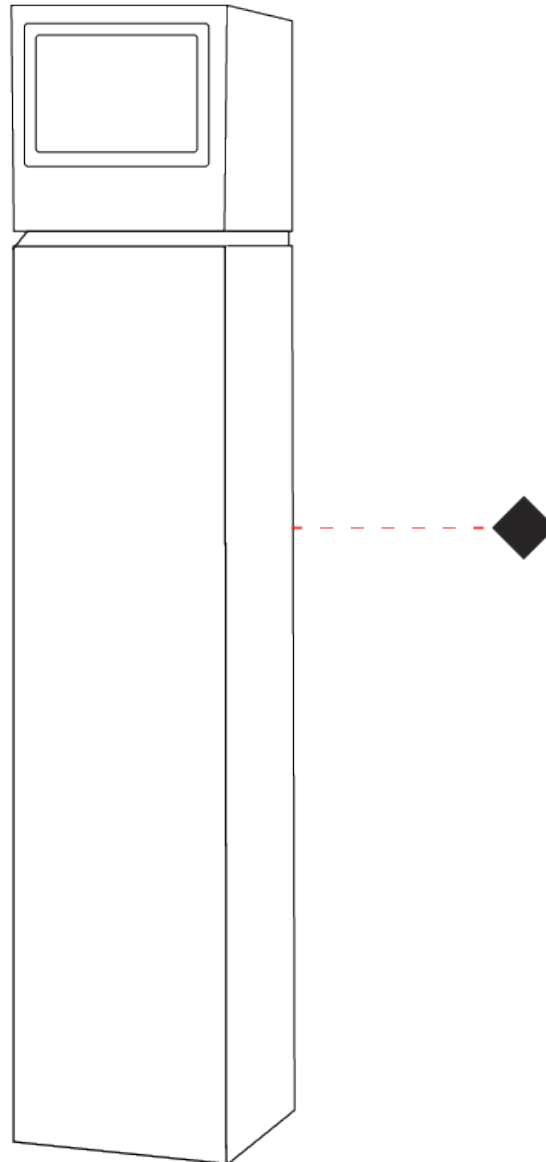

E

MINI ONE COLOR FINISH CHART

PROJECT

TYPE

SPECIFIER

QUANTITY

DATE

Fixture Finish

Gray - GRY

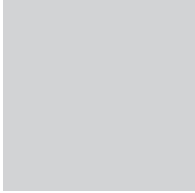

Anthracite - ANT



Digital: Not all screens are calibrated the same, and therefore, colors will appear differently between screens.

Physical: When texture is involved, there will be variations in color, character and tone within a product series and between product families.



PROJECT	
TYPE	
SPECIFIER	
QUANTITY	
DATE	

LEGEND

	floor-mounted		pivotal		special LED (upon request) RGB, RGBW, tunable, gold+, meat+, art+, fashion+
	wall and ceiling: recessed and surface mounted		rotating		warm dim / natural dimming LED
	ceiling-mounted and wall-mounted		illuminate tilted		rechargeable battery powered
	wall-mounted		color of suspension cable		fixture with natural vivid LED (upon request)
	omni-directional light distribution		length of suspension cable		color rendering index
	direct light distribution		reflector degree selection		color temperature
	direct/indirect light distribution		super spot		lumen (luminous flux)
	indirect light distribution		lens		efficacy (lumens per watt)
	asymmetric light distribution		lens pack		Unified Glare Rating (UGR) range from 5-40
	aura light distribution		shine ring		marine grade (AISI 316 stainless steel)
	round wall or ceiling cut-out		integrated shine ring with diffuser		walk on
	square wall or ceiling cut-out		free individual colors 01-29		drive on
	the supplied jig specifies the cutout dimensions		individual colors: 00 (free of charge), 01-25 (extra charge)		Dark Sky Compliance
	minimum distance (meters) lamp - object		luminaire part to be colored (F1)		Americans with Disabilities Act (less than 4" off the wall located between 27"-84" from floor)
	recessed depth		luminaire part to be colored (F2)		lamp protected against explosion
	ceiling thickness in mm		luminaire part to be colored (F3)		blown glass using traditional methods by master glass blower
	ceiling thickness selection		luminaire part to be colored (F4)		acoustic material
	dimmable DP (phase), DV (0-10V), DD (dali), DS (step-dim)		luminaire part to be colored (F5)		protection class I, protection insulation
	included or excluded LED driver/transformer/control gear		color of 3-circuit adaptor		protection class II, protection insulation
	separately switchable		indirect diffuser		ETL Certified to UL and CSA Standards
	sensor		direct diffuser		UL Certified to UL and CSA Standards
	remote control		ball-proof (upon request)		CSA Certified to UL and CSA Standards
	available upon request		accessory		Certified for North American Standards

IP RATING

	protected against ingress of solid bodies greater than 12.5mm (finger)
	protected against ingress of solid bodies greater than 2.5mm protected against sprays of water up to 60 degrees from the vertical (rain)
	protected against ingress of solid bodies greater than 1mm (wire) no protection against the ingress of moisture
	protected against ingress of solid bodies greater than 1mm (wire) protected against sprays of water up to 60 degrees from the vertical (rain)
	protected against ingress of solid bodies greater than 1mm (wire) protected against water splashed from all directions
	protected against limited ingress of dust (wet rooms/covered outdoor areas) protected against water splashed from all directions
	protected against ingress of dust protected against jets of water
	protected against ingress of dust protected against powerful jets of water or heavy seas
	protected against ingress of dust protected against immersion of water between 15cm - 1m for 30 minutes
	protected against ingress of dust protected against immersion of water under pressure for long periods

IK RATING

	protected against 0.14 joules impact (equivalent to 0.25kg mass dropped from 56mm above the surface)
	protected against 0.2 joules impact (equivalent to 0.25kg mass dropped from 80mm above the surface)
	protected against 0.35 joules impact (equivalent to 0.25kg mass dropped from 140mm above the surface)
	protected against 0.5 joules impact (equivalent to 0.25kg mass dropped from 200mm above the surface)
	protected against 0.7 joules impact (equivalent to 0.25kg mass dropped from 280mm above the surface)
	protected against 1 joules impact (equivalent to 0.25kg mass dropped from 400mm above the surface)
	protected against 2 joules impact (equivalent to 0.5kg mass dropped from 400mm above the surface)
	protected against 5 joules impact (equivalent to 1.7kg mass dropped from 300mm above the surface)
	protected against 10 joules impact (equivalent to 5.0kg mass dropped from 200mm above the surface)
	protected against 20 joules impact (equivalent to 5.0kg mass dropped from 400mm above the surface)